









 <b>1/4 x 16</b> <b>(A) x 8</b>	 <b>M5 x 20</b> <b>(B) x 4</b>	 <b>(C) x 8</b>	 <b>(D) x 1</b>	 <b>(E) x 1</b>	 <b>(F) x 1</b>
--	---	---	---	---	---



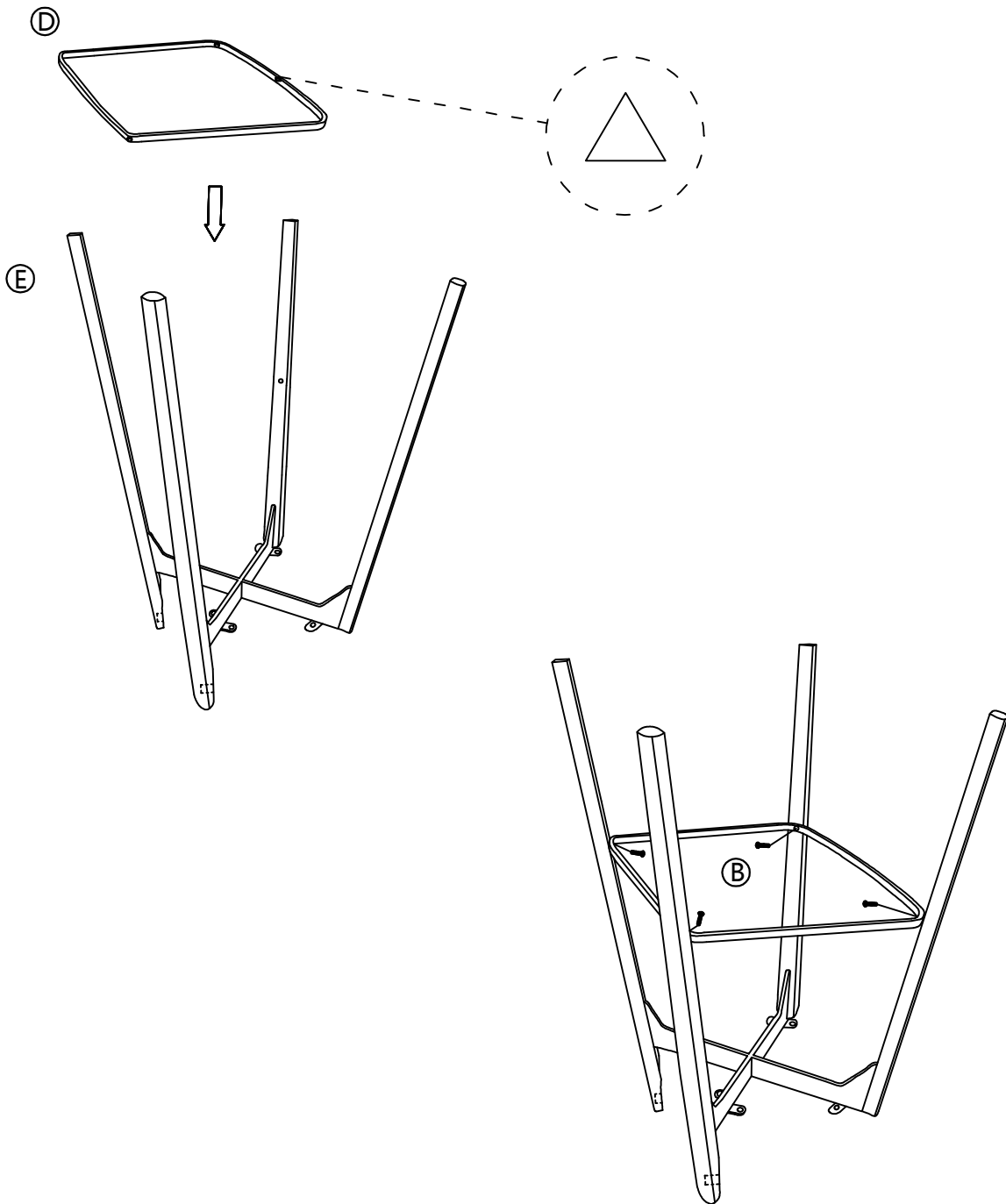
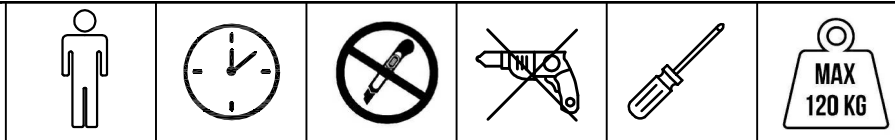

 <b>1/4 x 16</b> <b>(A) x 8</b>	 <b>M5 x 20</b> <b>(B) x 4</b>	 <b>(C) x 8</b>	 <b>(D) x 1</b>	 <b>(E) x 1</b>	 <b>(F) x 1</b>
--	---	---	---	---	---

